

WEIGHT=25g

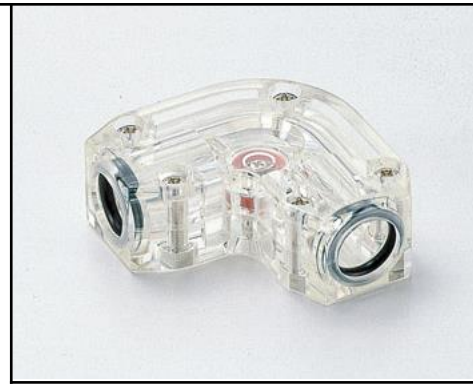

D/No.	B004031
NAME	ROLLER ELBOW
名称	ローラー エルボ

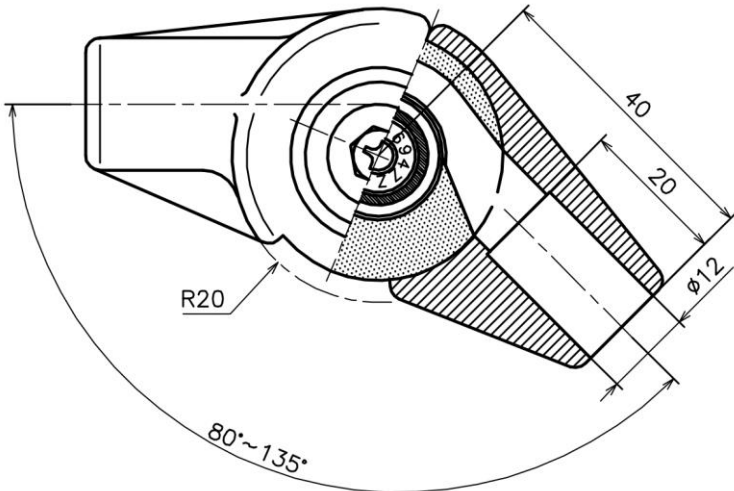

WEIGHT=30g



D/No.	B503023
NAME	ROLLER ELBOW
名称	ローラー エルボ

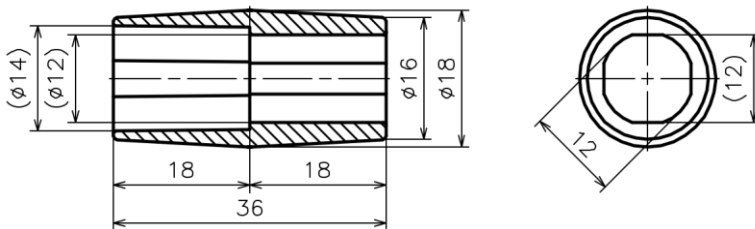

WEIGHT=5g



D/No.	B405046
NAME	SKIRT
名称	スカート

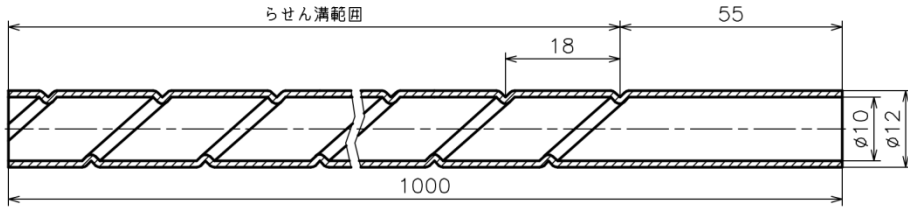

WEIGHT=90g

D/No.	C610030-10
NAME	SPIRAL CREEL TUBE
名称	スパイラル クリールチューブ

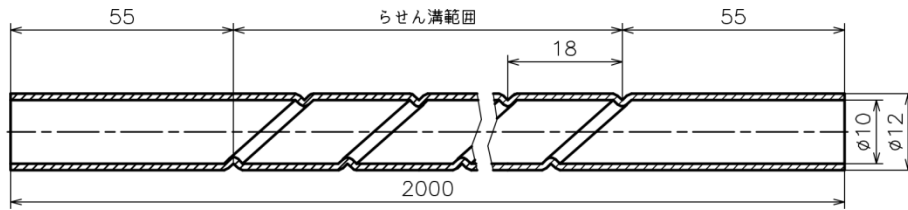

WEIGHT=180g

D/No.	C610030-20
NAME	SPIRAL CREEL TUBE
名称	スパイラル クリールチューブ

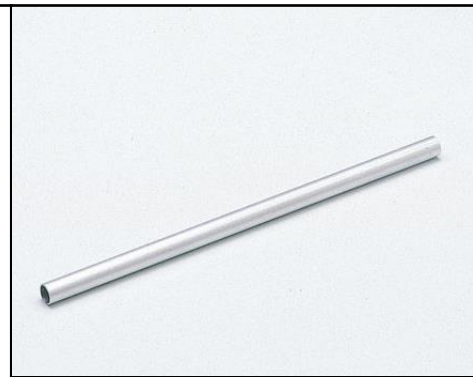
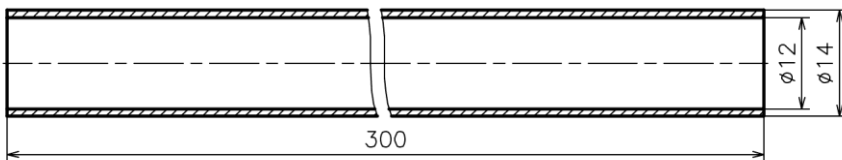

WEIGHT=27g

D/No.	A902003-C
NAME	CREEL PIPE
名称	クリールパイプ

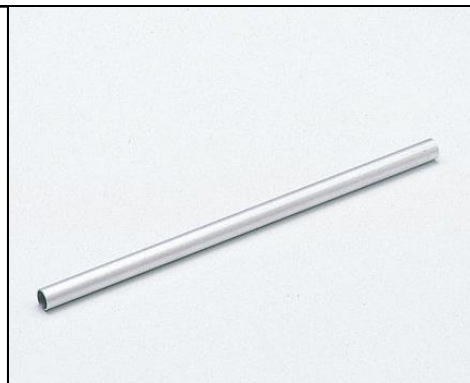
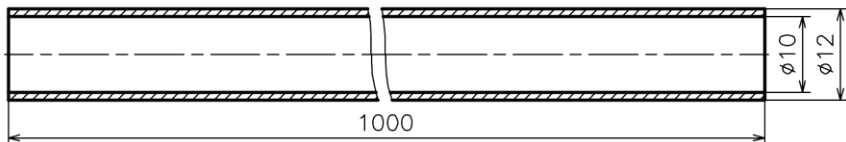

WEIGHT=90g

D/No.	B108021-B
NAME	CREEL PIPE
名称	クリールパイプ

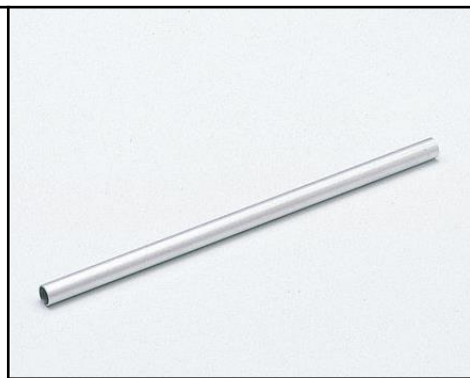
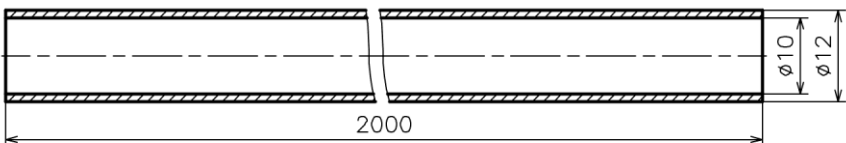

WEIGHT=180g

D/No.	B108021-A
NAME	CREEL PIPE
名称	クリールパイプ

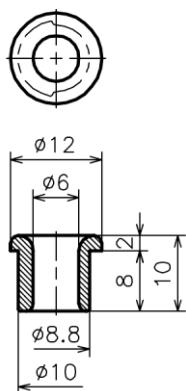

WEIGHT=1.70g

D/No.	C606030
NAME	EYELET GUIDE
名称	アイレットガイド